

# XT120

## Key Features

- 1 inch entry
- Unique Eighteen Sound elliptical shape (ESS)
- Flat front and compact size
- Injection moulded polyurethane construction
- Uniform on-axis and off-axis frequency response
- 90° x 60° horizontal and vertical constant coverage

## General Description

Featuring the unique Eighteen Sound elliptical shape, the XT120 Constant Coverage High Frequency Horn has been designed for use in sound systems where top quality is required. With a 1" throat entry diameter, the XT120 has been designed to match the Eighteen Sound 1 inch exit high frequency compression drivers family.

The XT120 maintains nominal 90° Horizontal x 60° Vertical pattern control, providing constant on-axis and off-axis frequency response from 2kHz to 16kHz in the horizontal plane and from 2.5kHz to 16kHz in the vertical plane.

The XT120 smooth flare rate provides constant directivity from 2.5kHz, low distortion and a spherical wave front, avoiding the typical reflections usually associated with diffraction horns.

The XT120 is made from high pressure injection moulded polyurethane foam and has been designed to be free of resonance and vibrations in order to assure maximum strength. Computer Aided Finite Element Analysis, as well as extensive testing were used to obtain the horn contours.

## Constant Coverage Horn



### 042108XT10

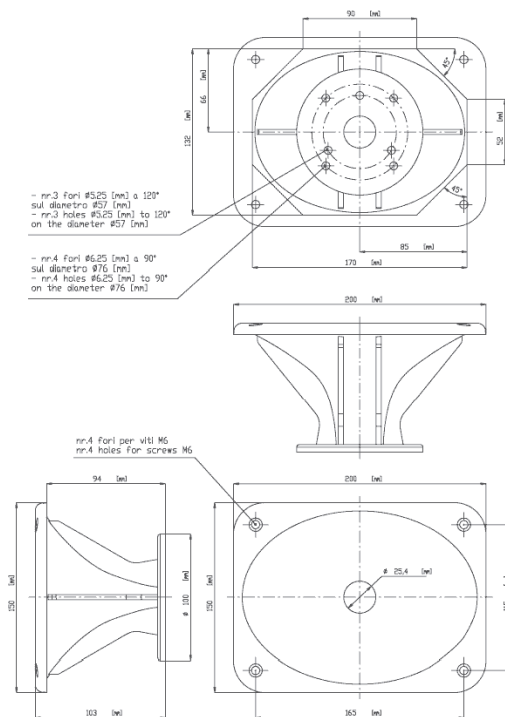

CONSTANT COVERAGE HORNS

**XT120**

Constant Coverage Horn

**GENERAL SPECIFICATIONS**

THROAT DIAMETER	25,4 mm (1 in)
HORIZONTAL COVERAGE (-6DB)	90° (1 ÷ -10) average range (2kHz ÷ 12,5kHz)
VERTICAL COVERAGE (-6 DB)	60° (15 ÷ -10) average range (2kHz ÷ 12,5kHz)
DIRECTIVITY INDEX	15 dB (2,5 ÷ 1,5)
USABLE FREQUENCY RANGE	Above 1.5 kHz
RECOMM. CROSS. FREQUENCY	2 kHz or more
SENSITIVITY (ON AXIS) (1)	108 dB
FREQUENCY RANGE	2kHz ÷ 18kHz
MATERIAL	Injection moulded Polyurethane

**MOUNTING INFORMATION**

Mouth Height	150 mm (5,9 in)
Mouth Width	200 mm (7,8 in)
Depth	103 mm (4,1 in)
Mouth Mounting Dimensions	4 6 mm ø holes on the edge of rectangle with 165 mm x 115 mm (6,5 x 4,53 in) sides
Driver Mounting Specs	3 5.25 mm ø holes on ø 57 mm (2.24 in) - 4 6.25mm ø holes on ø 76mm (3in)
Net weight	350 g (0,75 lb)

HORIZONTAL BEAMWIDTH – RED PLOT – A

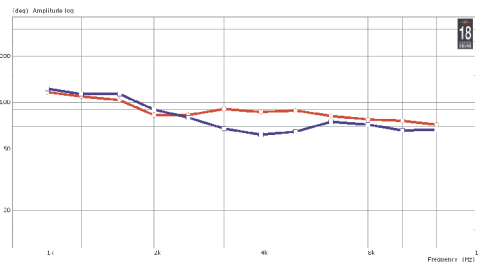

DIRECTIVITY INDEX – B

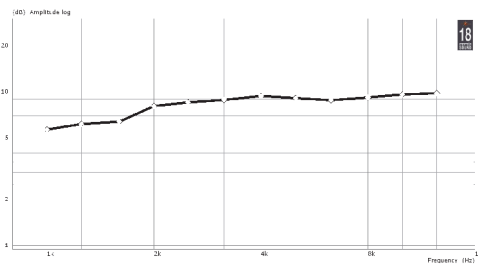

HORIZONTAL POLAR DIRECTIVITY MAP – C  
VERTICAL POLAR DIRECTIVITY MAP – D

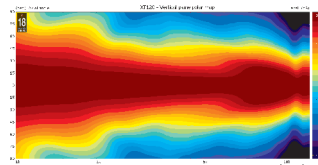
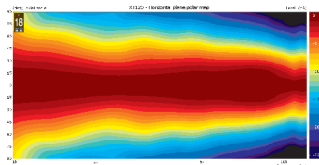

**NOTES**

(1) Sensitivity is measured at 1W input on HD125 rated impedance at 1m on axis from the mouth of the horn, averaged between 1KHz and 4 KHz.

**HORIZONTAL 1/3 OCTAVE POLARS**

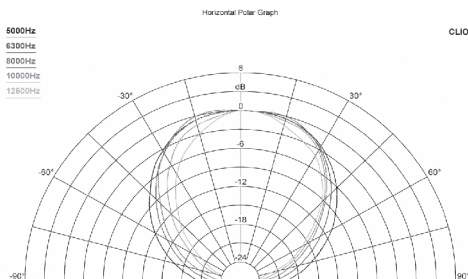
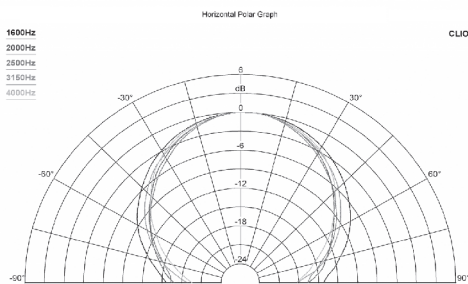

**VERTICAL 1/3 OCTAVE POLARS**

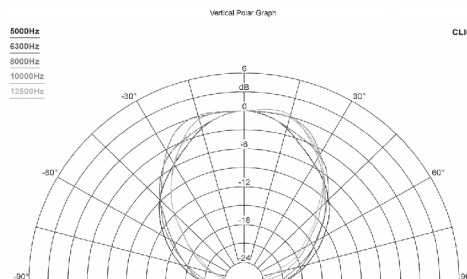
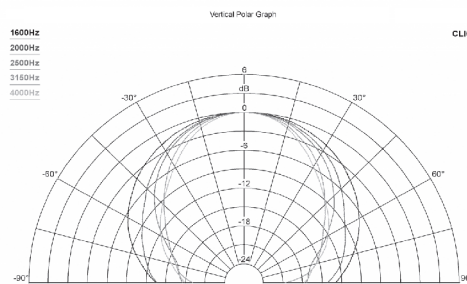

Eighteen Sound engages in research and product improvement. New materials and design refinements can be introduced into existing products without notice.

